

OMEGA POWER SYSTEM

Rotary Screw Compressors

- CSA Approved
- CRN Approved
- 100% Continuous Duty Operation
- Quiet Operation
- High Efficiency Rotary Airends
- Energy Saving Options

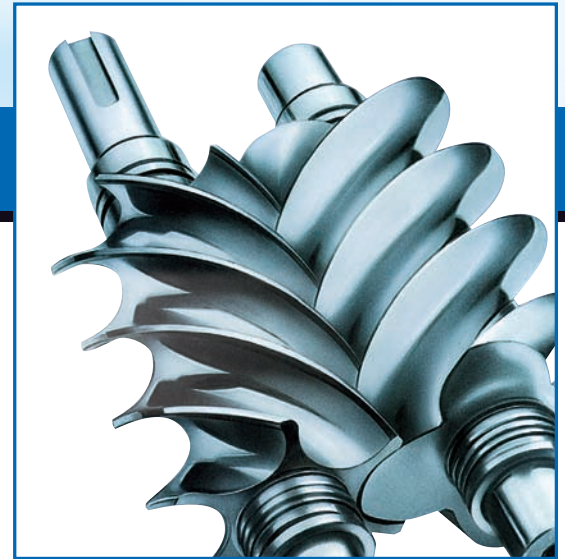

For us, it's not just business. It's personal.

Rotary Screw Compressors

PS 1000 SERIES - BELT DRIVEN

The PS 1000 screw compressor series unifies at the same time high performances together with low consumption. Room is quite a considerable cost when designing a compressed air control unit. OMEGA POWER SYSTEM has designed a control unit complete with compressor, oil separating filter and condensate discharge in the space of simply 0.59 cubic metres.

HIGH-PERFORMANCE LOW-NOISE TRANSMISSION

The compressor is driven by an electric motor by means of a POLY-V belt. This operating system ensures a perfect screw-motor alignment and quiet operation, lasting reliability and high performance.

AIREND

Composed of a male and a female rotor with asymmetrical profiles. The rotors are mounted on roller and ball bearings which support their radial loads and axial thrust. The compression is accomplished in a single stage. The compression heat is taken away by the oil injected between the two rotors.

ELECTRIC MOTOR

Totally enclosed with forced ventilation, protection IP 55 class F with temperature rise in class B. It guarantees the highest reliability in the hardest working conditions, together with the lowest running cost.

AIR-OIL COOLING UNIT:

With a large radiating surface, to reduce pressure drop and allow the maximum value of the unit.

ELECTRIC FAN

With high static pressure.

OIL FILTER CARTRIDGE

Complete with by-pass.

THREE-STAGE AIR-OIL SEPARATOR

(Mechanical coalescing and filtration)

With spin-off cartridge. CRN approved for Canada.

CONTROL PANEL

Complete with hour counter, selector for continuous operation or timed stop, pressure gauge, high temperature reset, warning lights for alarm and voltage presence, emergency isolating switch.

TANK MOUNTED (optional)

PS1000 Series models may be tank mounted on 80 or 120gal. ASME approved air receivers. CRN approved for Canada. (ie. PS-1011-10 on a 80gal. air receiver becomes model number PS-1011-10-80T)

DRYER (optional)

With cooling cycle, designed to work in the worst conditions. The dimensions of the heat exchangers have been calculated to withstand high temperatures and humidity of the compressed air. The system is complete with condensate discharge which eliminates air loss in the discharge phase. Dryer option complete with prefilter, bypass and 80 or 120gal. air receiver (ie. PS-1011-10 on a 120gal. air receiver becomes model number PS-1011-10-120TD)



PS-1000



PS-1000
with optional air receiver



PS-1000
with optional air dryer
and air receiver

OMEGA
POWER SYSTEM

Rotary Screw Compressors

Specifications

PS 1000 SERIES - BELT DRIVEN

Model	Max Pressure		F.A.D.		Power		Noise lev. dB(A)	Weight	
	bar max	Psig max	m3/min	CFM	kW	Hp		Kg	lbs
PS 1004-10	10	145	0.51	18	4	5	64	130	287
PS 1005-10	10	145	0.72	25	5.5	7.5	64	130	287
PS 1007-10	10	145	0.98	35	7.5	10	67	130	287
PS 1011-10	10	145	1.45	51	11	15	64	200	441
PS 1015-10	10	145	1.80	64	15	20	64	210	463

The air flow rates have been measured at the following working pressure.
9.5 bar for mod. 10 bar

The data and performances were recorded in accordance with standard ISO 1217. The sound level was measured in accordance with PNEUROP/CAGI standards.

Notes:

- All models are CSA approved.
- All models complete with CRN approval for Canada.
- All models factory tested prior to shipment.
- All dimensional data in millimetres.

PS 1004-1007

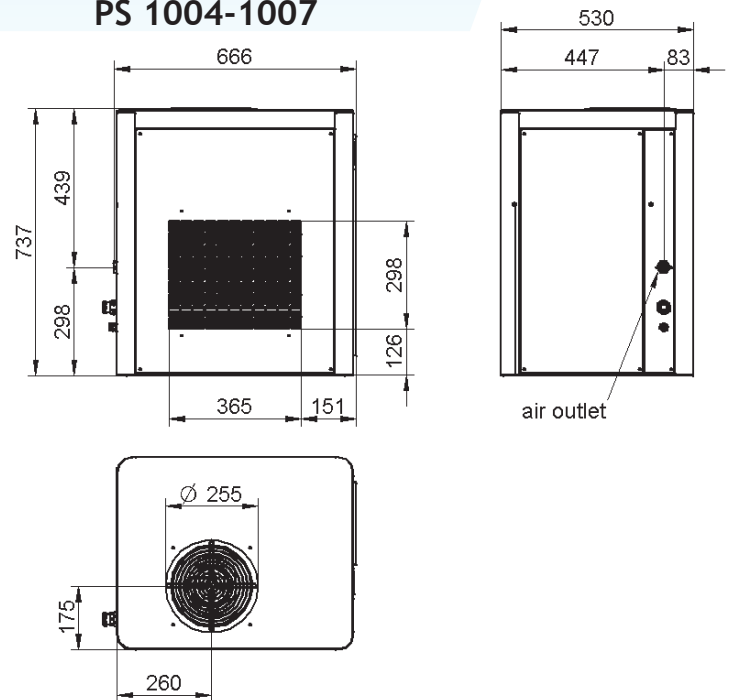

PS 1011-1015

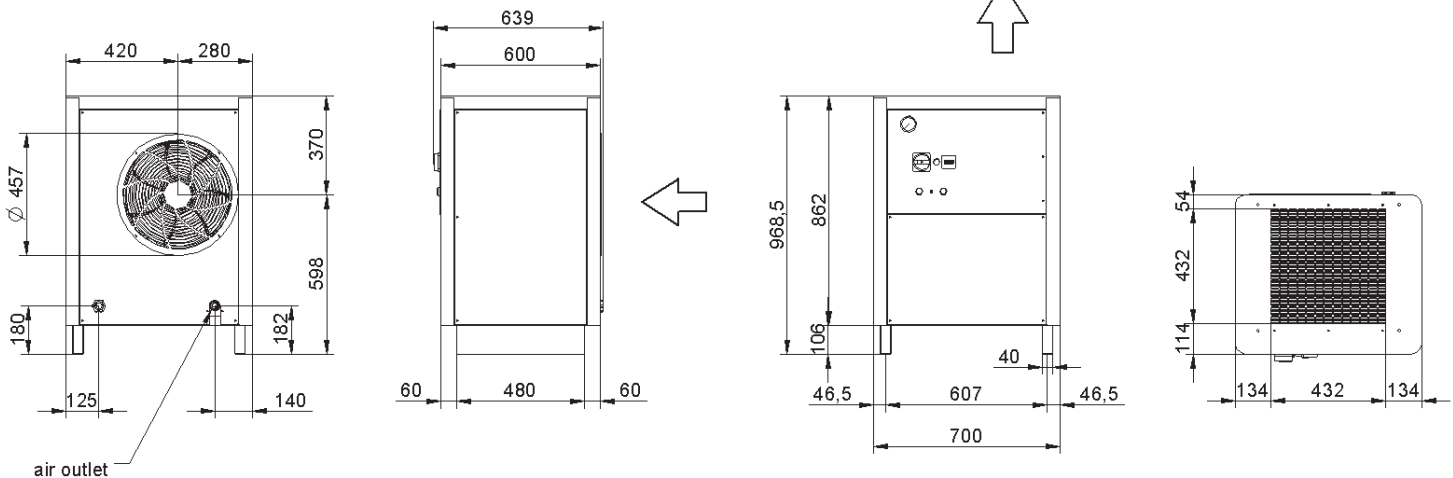

OMEGA
POWER SYSTEM

Rotary Screw Compressors

PS 1300 SERIES - DIRECT DRIVE

THE AIREND UNIT HAS A HIGH YIELD AND IS DESIGNED TO WORK FOR A LONG TIME

It is composed by two rotors with 5/6 (male/female) lobes combination with asymmetrical profiles. The forged steel rotors are cut using machines with numerical control and are fitted on roller and ball bearings which support their radial loads and axial thrust. The compression takes place in a single stage. The compression heat is eliminated by the oil injected between the two rotors.

ELECTRIC MOTOR

Totally enclosed with forced ventilation, protection IP 55 class F with temperature rise in class B. Chosen to guarantee maximum reliability in the hardest working conditions, together with the lowest running cost.

AIR-OIL COOLING UNIT

With a large radiating surface, to reduce pressure drop and allow the maximum value of the unit.

AXIAL ELECTRIC FAN

With high static pressure.

HIGH EFFICIENCY CARTRIDGE OIL FILTER

Complete with by-pass.

PRE-FILTER IN SYNTHETIC FIBRE

For protection against impurities in the intake air.

THREE-STAGE AIR-OIL SEPARATOR

(Mechanical coalescing and filtration) with spin-off cartridge. CRN approved for Canada.

TANK MOUNTED (optional)

PS 1300 Series models may be tank mounted on a 80 or 120gal. ASME approved air receivers. CRN approved for Canada. (ie. PS-1307-10 on a 80gal. air receiver becomes model number PS-1307-10-80T)

DRYER (optional)

With cooling cycle, designed to work in the hardest conditions. The dimensions of the heat exchangers have been calculated to withstand high temperatures and humidity of the compressed air. The system is complete with condensate discharge with eliminates air loss in the discharge phase. Also complete with prefilter, bypass and 80 or 120gal. air receiver. (ie. PS-1307-10 on a 120gal. air receiver becomes PS-1307-10-120TD)

HIGH PERFORMANCE AND SILENT DRIVE SYSTEM

The compressor element is driven directly by the electric motor by means of a couple of helical gears. This drive system guarantees perfect alignment of the screw-motor unit along with silent operation, lasting reliability and lower consumption. The performances are increased if compared to compressors equipped with the conventional belt transmission.

EPS4.2 ELECTRONIC CONTROLLER

is an advanced electronic controller. It allows optimum compressor regulation. The system also allows a sequential network up to six compressors. EPS 4.2 is equipped with an alphanumeric LCD display for showing the functions, the maintenance and the instructions for machine reset, together with the programming of the work parameters. It is also equipped with a date clock and weekly timer for displaying the time and the date, together with the daily programming of the machine start. The system can be remote-controlled with a serial interface connecting to a terminal. The EPS4.2 controller display the presence of malfunctioning alarm and the expiration of maintenance intervals.



PS 1300



PS 1300 with optional air receiver

OMEGA
POWER SYSTEM

Rotary Screw Compressors

Specifications

PS 1300 SERIES - DIRECT DRIVE

Model	Max Pressure		F.A.D.		Power		Noise lev. dB(A)
	bar max	Psig max	m3/min	CFM	kW	Hp	
PS 1307-10	10	145	0.98	35	7.5	10	64
PS 1311-10	10	145	1.53	54	11	15	64
PS 1315-10	10	145	1.92	68	15	20	65

Compressor	Weight		Dimensions LxWxH
	kg	lbs	
PS 1307	210	463	1160x597x1034
PS 1311	230	507	1160x597x1034
PS 1315	240	529	1160x597x1034

The air flow rates have been measured at the following working pressure.

9.5 bar for mod. 10 bar

The data and performances were recorded in accordance with standard ISO 1217. The sound level was measured in accordance with PNEURO/OP/CAGI standards.

Notes:

All models are CSA approved.

All models complete with CRN approval.

All models factory tested prior to shipment.

All dimensional data in millimetres.

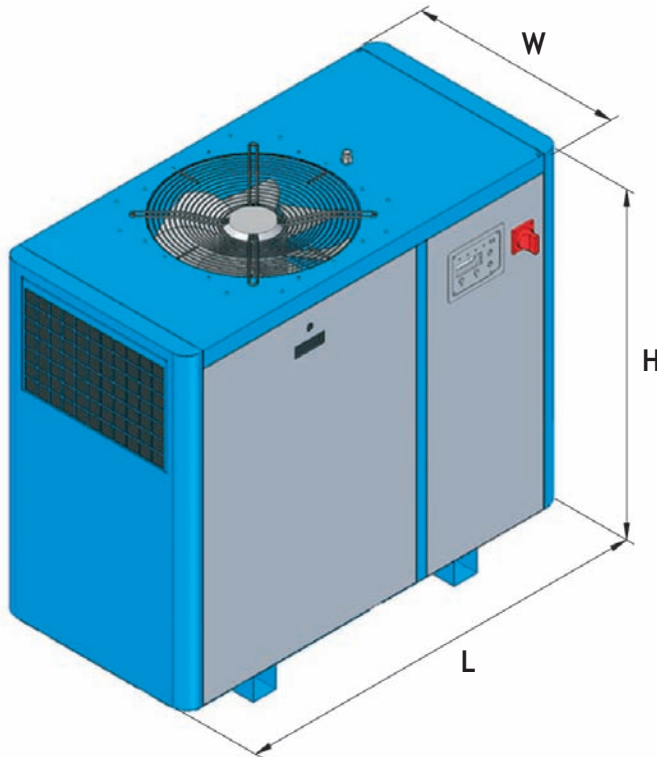

Rotary Screw Compressors

PS 1500 - 2000 SERIES DIRECT DRIVE

A TOTALLY NEW DIRECT DRIVEN COMPRESSOR SERIES

The direct transmission allows a perfect alignment of the airend to the motor for high dependability and performances.



TRANSMISSION

The airend-motor coupling is obtained by means of a gear box designed and manufactured by OMEGA POWER SYSTEM. If compared to conventional belt driven screw compressors, the new PS 1500 and 2000 series compressors reach a 5% energy saving. As a further advantage, this kind of transmission eliminates the service operations necessary to tighten and replace the belts

THE AIREND IS HIGH EFFICIENT AND IS DESIGNED FOR LONG LIFE OPERATION

Single stage oil-injected double screw compressor, composed by a 5/6 profile with asymmetrical profiles. The forged steel rotors are cut using machines with numerical control and are fitted on roller and ball bearings which support their radial loads and axial thrust. The compression takes place in a single stage. The compression heat is eliminated by the oil injected between the two rotors.

ELECTRIC MOTOR

Totally enclosed with forced ventilation, protection IP 55 class F with temperature rise in class B. It guarantees the highest reliability in the hardest working conditions, together with the lowest running cost.

AIR-OIL COOLING UNIT

With a large radiating surface to reduce pressure drop and allow the maximum value of the unit. Air and oil gets cooled by means of an electric fan.

AXIAL ELECTRIC FAN

With high static pressure.

OIL FILTER CARTRIDGE

Complete with by-pass.

THREE-STAGE AIR-OIL SEPARATOR

(Mechanical coalescing and filtration) with spin-off cartridge. The separation takes place in three stages:

1. Centrifugation
2. Condensation
3. Oil separation by means of a multistage oil-separating filter

HIGH EFFICIENT CONDENSATE SEPARATOR

It is designed to detect and separate water from oil and is completed by a timed electronic discharge, designed to reduce to a minimum.

PRE-FILTER IN SYNTHETIC FIBRE

For protection against impurities in the intake air.

EPS 4.2 CONTROL PANEL

EPS 4.2 is an advanced electronic controller. It allows optimum compressor regulation. The system also allows a sequential network of up to six compressors. EPS 4.2 is equipped with an alphanumeric LCD display for showing the functions, the maintenance and the instructions for machine reset, together with the programming of the work parameters. It is also equipped with a date clock and weekly timer for displaying the time and the date, together with the daily programming of the machine start. The system can be remote-controlled with a serial interface connecting to a terminal. The EPS4.2 controller display the presence of malfunctioning alarm and the expiration of maintenance intervals.

Rotary Screw Compressors

PS 1500 - 2000 SERIES DIRECT DRIVE



PS 1522



PS 2030

Specifications

Model	Max Pressure		F.A.D.		Power		Noise lev. dB(A)	Weight	
	bar max	Psig max	m3/min	CFM	kW	Hp		kg	lbs
PS 1518-7.5	7.5	109	2.92	103.1	18.5	25	69	375	827
PS 1518-10	10	145	2.60	91.8	18.5	25	69	375	827
PS 1518-13	13	175	2.10	74.2	18.5	25	69	375	827
PS 1522-7.5	7.5	109	3.60	127.1	22	30	69	375	827
PS 1522-10	10	145	3.10	109.5	22	30	69	375	827
PS 1522-13	13	175	2.60	91.8	22	30	69	375	827



Model	Max Pressure		F.A.D.		Power		Noise lev. dB(A)	Weight	
	bar max	Psig max	m3/min	CFM	kW	Hp		kg	lbs
PS 2030-7.5	7.5	109	4.80	169.5	30	40	69	605	1,334
PS 2030-10	10	145	4.30	151.9	30	40	69	605	1,334
PS 2030-13	13	175	3.60	127.1	30	40	69	605	1,334
PS 2037-7.5	7.5	109	5.80	204.8	37	50	69	625	1,378
PS 2037-10	10	145	5.25	185.4	37	50	69	625	1,378
PS 2037-13	13	175	4.50	158.9	37	50	69	625	1,378

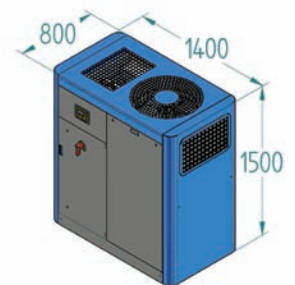

The air flow rates have been measured at the following working pressures:
7 bar for mod. 7.5 bar - 9.5 bar for mod. 10 bar - 12.5 bar for mod. 13 bar

The data and performances were recorded in accordance with standard ISO 1217. The sound level was measured in accordance with PNEURO/CAGI standards.

Notes:

All models are CSA approved.

All models complete with CRN approved for Canada.

All models factory tested prior to shipment.

All dimensional data in millimetres.

OMEGA
POWER SYSTEM

Rotary Screw Compressors

PS 3100 SERIES - DIRECT DRIVE



PS 3175

THE "PS 3100-6000" AIR-COOLED AIR COMPRESSOR is an oil injected, rotary screw compressor series complete with all typical accessories of a air compression unit such as: electric motor, starter, command and control panel, final cooler, condensate separator with timed discharge and soundproof cabinet. This compressor is totally air-cooled and is designed for a continuous duty.

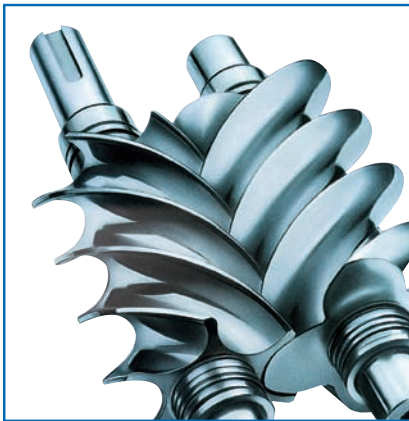

COMPRESSOR ELEMENT WITH HIGH YIELD of the lubricated single-stage rotary screw type; it is composed of two rotors, a male one with 5 lobes and a female one with 6 slots, with asymmetrical profiles. The forged steel rotors are cut using machines with numerical control and are fitted on roller and ball bearings which support their radial loads and axial thrust. Compression takes place in a single stage. The compression heat is taken away by the oil injected between the two rotors.

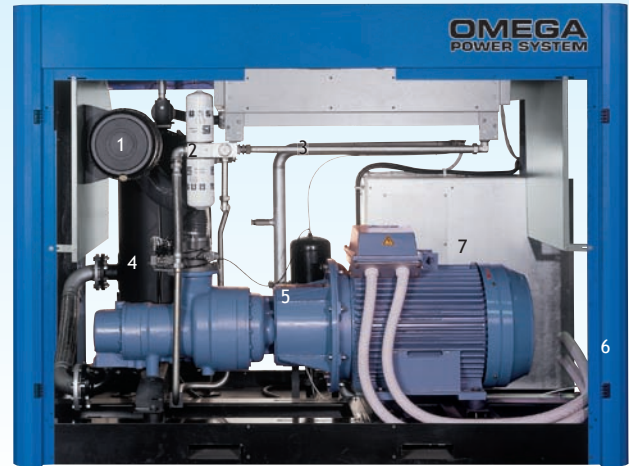

MAIN COMPONENTS

1. Two stage air filter
2. Oil filter with cartridge
3. Easily inspectable Air-Oil cooling unit
4. Three stage Air-Oil Separator
5. High Efficient Condensate Separator
6. Prefilter in Synthetic Fibre
7. Starting Equipment complying to the CEI Regulation

HIGH-PERFORMANCE SILENT TRANSMISSION

The compressor element is driven directly by the electric motor by means of a flexible coupling and a couple of helical gears. This drive system guarantees perfect alignment of the screw-motor unit along with silent operation, lasting reliability and high performance.

ELECTRIC MOTOR

The electric motor is rated in insulation class F and protection IP 55. In the description shown below it is given the definition of protection grade for IP 23 and IP 55 respectively:

IP 23

- protection against the penetration of foreign bodies with a diameter larger than 12 mm.
- protection against drops of water with incidence 60°
- total protection against splashes of liquids and harmful deposits of dust inside the windings.
- total protection against jets of water shot from any direction.

TWO-STAGE AIR FILTER

This is how the filtration is accomplished

1. centrifugation and storage of dust in the container
2. filtration by means of a cartridge with degree of particle separation (99.6% at 2 μ)

Rotary Screw Compressors

PS 3100 SERIES - DIRECT DRIVE

HIGH EFFICIENCY CARTRIDGE OIL FILTER

Complete with by-pass.

AIR-OIL COOLING UNIT

With a large radiating surface to reduce pressure drop and allow the maximum value of the unit. Air and oil gets cooled by means of an electric fan.

THREE-STAGE AIR-OIL SEPARATOR

(Mechanical coalescing and filtration) with spin-off cartridge. The separation takes place in three stages: Centrifugation, condensation and oil separation by means of a multistage oil-separating filter.

HIGH EFFICIENCY CONDENSATE SEPARATOR

Acts on the water-oil particles complete with timed electronic discharge, designed to reduce air loss during the discharge phase to a minimum.

PRE-FILTER IN SYNTHETIC FIBRE

Protecting against impurities in the intake air.

REGULATION AND CONTROL CIRCUIT

The regulation and control system adopted for this series of machine processes the pressure and temperature signals by means of sensors located inside the compression unit and control their operation, in order to guarantee the air flow rate required by the user continuously with almost constant pressure and with specific energy consumption below the traditional values. Briefly, the system allows:

- display the operating conditions of the main components of the compression control unit;
- modify the programmed working conditions;
- automatic identification of the on-off or proportional operating times of the compressor according to the working conditions, in order to reduce the energy consumption of the compressor unit;
- continuous monitoring of any maintenance jobs, depending on the environmental and working conditions of the compression unit, thus making the service safer and less expensive;
- protection of the compressor against lack of phase, incorrect direction of rotation, high temperature or pressure, malfunctioning of the transducers;
- protection of the electrical motor and of the electrical fan against overload.

EPS 3

This Control Unit is an advanced electronic controller, it provides the regulation of the compressed air control unit allowing the highest compressor regulation flexibility. The system also allows a sequential network of up to 6 compressors. It is equipped with an alphanumeric LCD display for showing the functions, the maintenance and the instructions for the machine reset, together with the programming of the working parameters. It is also equipped with a date clock and weekly timer for displaying the time and the date, together with the daily programming of the machine start. The system can be remote-controlled with a serial interface connecting to a terminal.



Rotary Screw Compressors

PS 3100 SERIES - DIRECT DRIVE

1. Aired
2. Transmission
3. Electrical Motor
4. Two stages air filter
5. Oil filter with cartridge
6. Easily inspectable Air-Oil cooling unit
7. Three stage Air-Oil Separator
8. Highly Efficient Condensate Separator

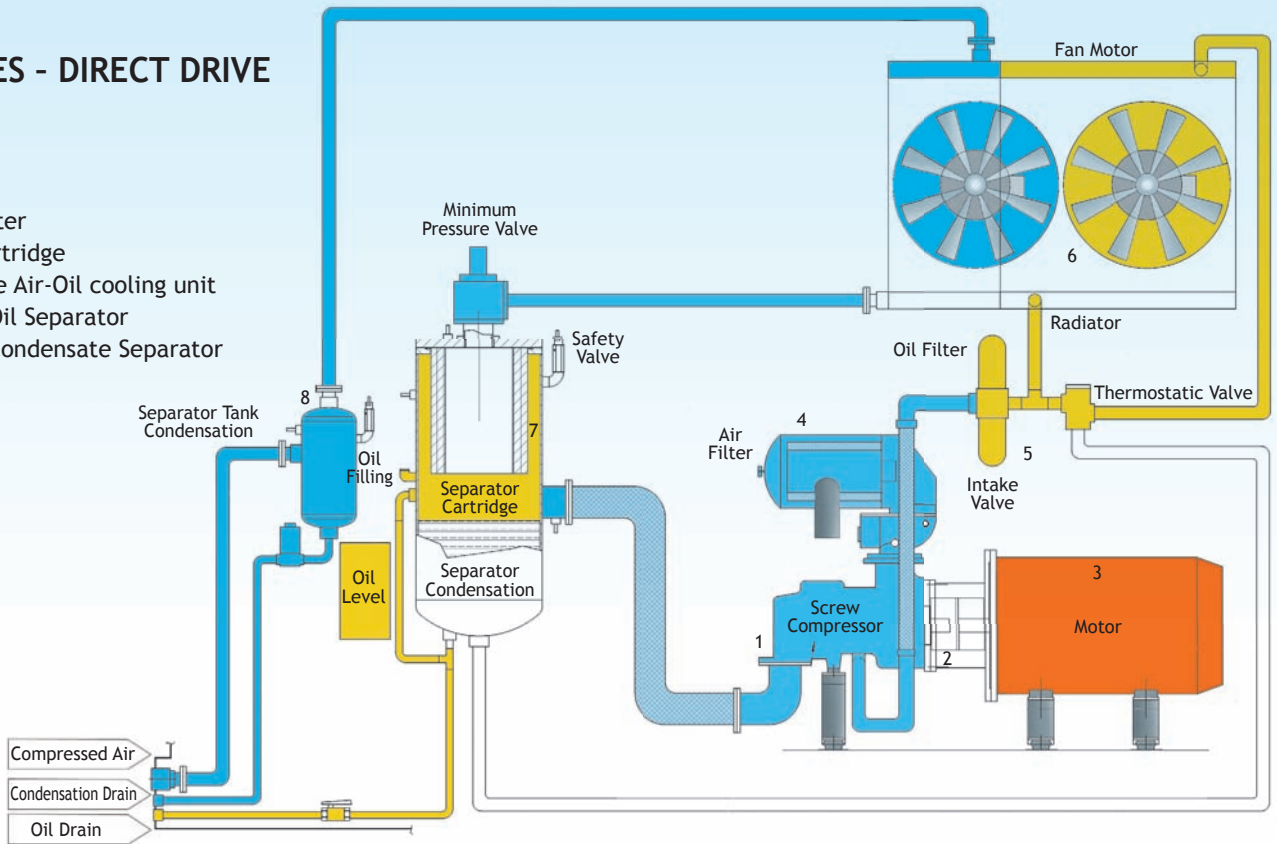

Specifications

Model		Max Pressure		F.A.D.		Power		Noise lev. dB(A)	Weight	
		bar max	Psig max	m3/min	CFM	kW	Hp		kg	lbs
PS 3145-7.5	3	7.5	109	7.8	275	45	60	73	950	2,095
PS 3145-10	3	10	145	6.3	222	45	60	73	950	2,095
PS 3145-13	3	13	175	5.4	190	45	60	73	950	2,095
PS 3155-7.5	3	7.5	109	9.8	345	55	75	73	1050	2,315
PS 3155-10	3	10	145	8.2	289	55	75	73	1050	2,315
PS 3155-13	3	13	175	7.0	247	55	75	73	1050	2,315
PS 3175-7.5	3	7.5	109	12.6	444	75	100	73	1250	2,756
PS 3175-10	3	10	145	10.5	370	75	100	73	1250	2,756
PS 3175-13	3	13	175	8.8	310	75	100	73	1250	2,756



The air flow rates have been measured at the following working pressures:
 7 bar for mod. 7.5 bar - 9.5 bar for mod. 10 bar - 12.5 bar for mod. 13 bar

The data and performances were recorded in accordance with standard ISO 1217. The sound level was measured in accordance with PNEUROP/CAGI standards.

Notes:

- All models are CSA approved.
- All models complete with CRN approved for Canada.
- All models factory tested prior to shipment.
- All dimensional data in millimetres.

OMEGA

POWER SYSTEM

Rotary Screw Compressors

VARIABLE SPEED DRIVE

The use of compressed air is indispensable in all industrial applications as a utility and as raw material in the production processes. The compressed air is versatile, flexible and a safe form of energy, but it is very expensive if not used correctly if compared to traditional compressors, the advantages of these advanced new machines can be summed up as follows:

1. Elimination of electric absorption peaks in the motor's start-up phase.
2. Optimisation of the electric consumption of the compressor with a ratio directly proportional to the request for compressed air.
3. Constant regulation of the working pressure with a maximum drift of 0.2 bar as to the operating set pressure.
4. Elimination of the waste of compressed air in ON-OFF regulation determined by the need to depressurise the air-oil tank every time a vacuum is created in the machine.
5. Reduced wearing of the mechanical parts, screw bearings and motor, with consequent reduction of the maintenance costs.

PS DV SERIES - VARIABLE SPEED



OMEGA
POWER SYSTEM

Rotary Screw Compressors

PS DV SERIES - VARIABLE SPEED

Statistical data recorded by OMEGA POWER SYSTEM over a three-year period in industries with a continuous cycle have shown the following parameters concerning the cost of compressed air in a 3 years period:

Compressor Purchase	19.3%
Maintenance	6.4%
Energy	74.3%

STANDARD SCREW COMPRESSOR

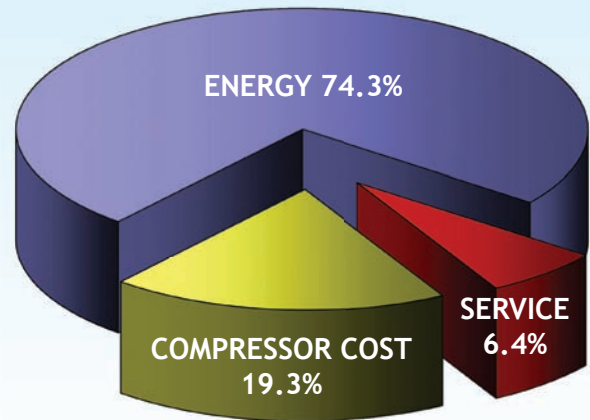

Today it is necessary to use flexible production systems with low energy consumption. Respect for nature and energy saving become priorities when choosing any production investment. Measurements conducted on typical application show how the air demand varies during daily or weekly cycles.

% kW max.

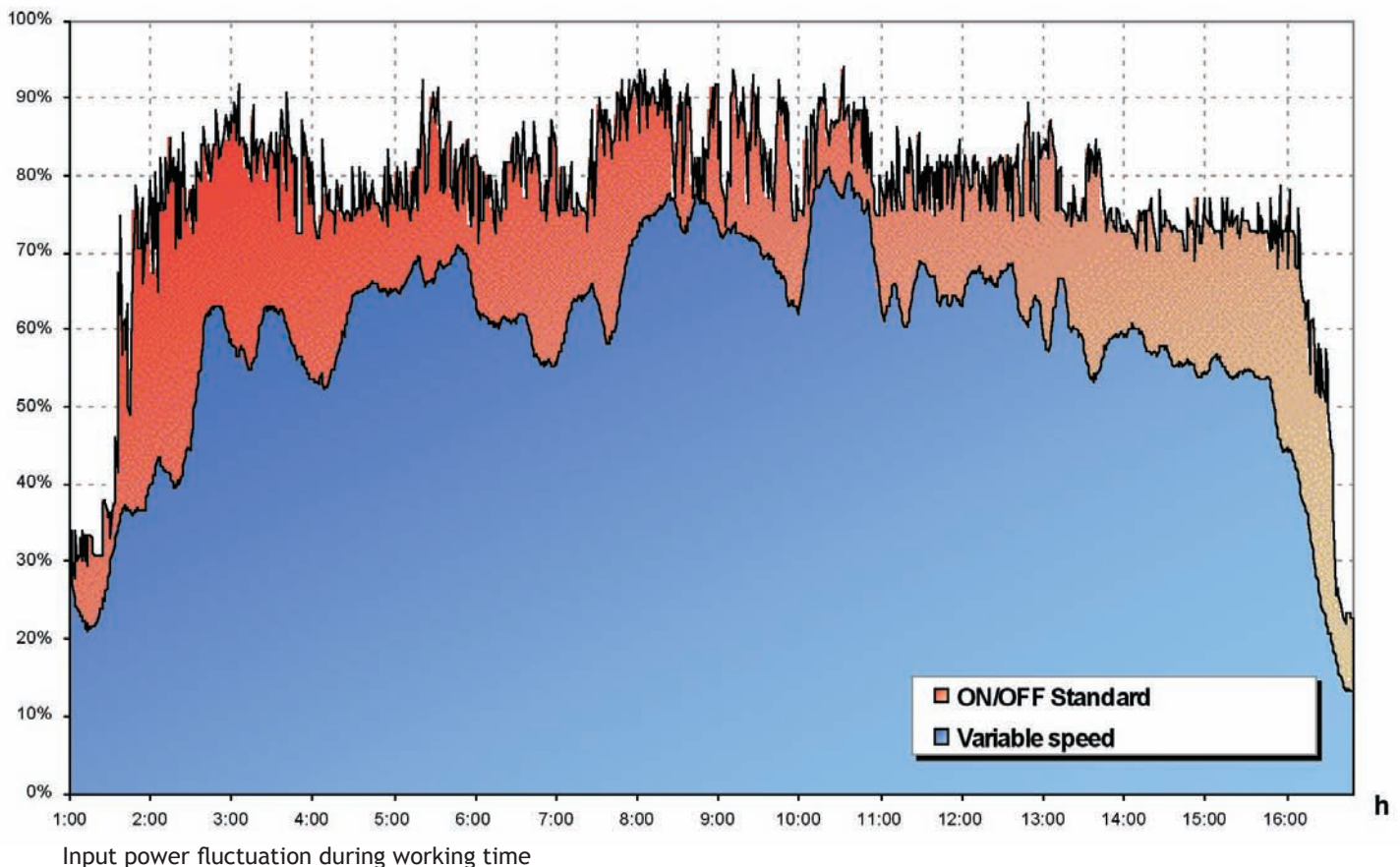

Rotary Screw Compressors

PS DV SERIES - VARIABLE SPEED

The speed regulation allowed by the motor-speed variation controller allows to tune the air delivered to the air demand. This gives an energy saving thanks to:

- lower maximum power absorbed
- no vacuum operation conditions
- reduced pressure range regulation
- no pressure losses for depressurization of air/oil tank
- less absorbed power variation

The picture on the side show the energy saving reached using variable speed.

THE PS-DV AIR-COOLED SCREW COMPRESSOR

This is a rotary screw compressor with oil injection, complete with all the typical accessories of a compression control unit such as: electric motor, starter, command and control panel, final cooler, condensate separator with timed discharge and soundproof cabinet. The control unit, which is totally air-cooled, is designed for continuous duty. The high standard in Power System design, together with the most advanced construction technology, put this series of compressors in the lead in regards to technical, functional and operating characteristics.

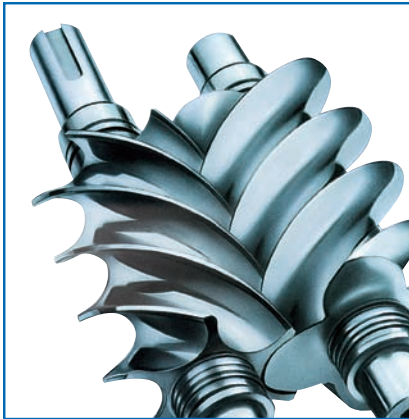

COMPRESSOR ELEMENT WITH HIGH YIELD

The lubricated single-stage rotary screw type; it is composed of two rotors, a male one with 5 lobes and a female one with 6 slots, with asymmetrical profiles. The forged steel rotors are cut using machines with numerical control and are fitted on roller and ball bearings which support their radial loads and axial thrust. Compression takes place in a single stage. The compression heat is taken away by the oil injected between the two rotors.

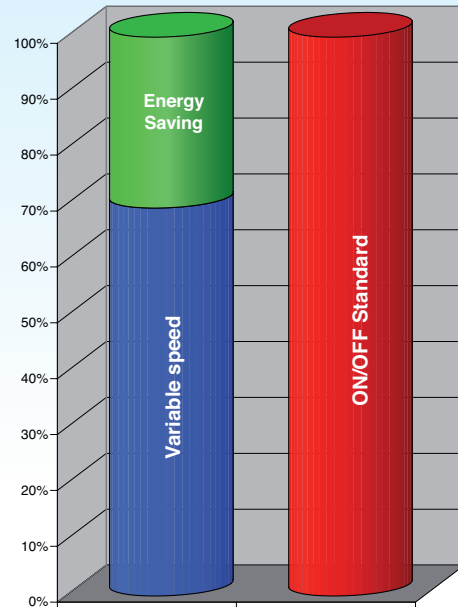

HIGH-PERFORMANCE SILENT TRANSMISSION

The compressor element is driven directly by the electric motor by means of a flexible coupling and a couple of helical gears. This drive system guarantees perfect alignment of the screw motor unit along with silent operation, lasting reliability and high performance.

ELECTRICAL MOTOR

The electric motor is rated in insulation class F and protection IP 55. In the description shown below it is given the definition against foreign bodies for IP 23 and IP 55 respectively:

IP 23

- Protection against the penetration of foreign bodies with a diameter larger than 12 mm.
- Protection against drops of water with incidence 60°

IP 55

- Total protection against splashes of liquids and harmful deposits of dust inside the windings.
- Total protection against jets of water shot from any direction.

TWO-STAGE AIR FILTER

This is how the filtration is accomplished

1. centrifugation and storage of dust in the container
2. filtration by means of a cartridge with degree of particle separation (99.6% at 2 μ)

Rotary Screw Compressors

PS DV SERIES - VARIABLE SPEED

HIGH EFFICIENCY CARTRIDGE OIL FILTER
Complete with by-pass

AIR-OIL COOLING UNIT

With a large radiating surface to reduce pressure drop and allow the maximum value of the unit. Air and oil gets cooled by means of an electric fan.

HIGH EFFICIENCY CONDENSATE SEPARATOR

Acts on the water-oil particles complete with timed electronic discharge, designed to reduce air loss during the discharge phase to a minimum.

THREE-STAGE AIR-OIL SEPARATOR

Is designed to guarantee the maximum efficiency of oil-air separation and to reduce to minimize the oil content in compressed air. The separation takes place in three stages: centrifugation, condensation and oil separation by means of a multistage oil-separating filter.

PRE-FILTER IN SYNTHETIC FIBRE

For protection against impurities in the intake air.



THE VSD

The frequency inverter is of the vectorial type and ensures the precise control of the motor speed and torque, even without using an encoder. The use of the inverter allows:

- motor starting torque up to 200% for heavy duty
- accurate torque control
- torque response time of 1-2 ms

REGULATION AND CONTROL SYSTEM

The regulation and control system allows the following:

1. Automatic determination, from time to time, of the on-off or proportional operating time of the compressor, so the energy costs of the control unit are reduced.
2. Automatic determination of any maintenance jobs, depending on the environmental and working conditions of the control unit, making the service safer and less expensive.
3. Protecting the compressor in case of no phase due to a wrong rotation (as in cases where too high pressure is arisen)
4. Protect the electrical drive motor and the fan from overload conditions.

The VSD Screw Compressors of the series PS 1300, PS 1500 and PS 2000 are equipped with control panel EPS 4.2

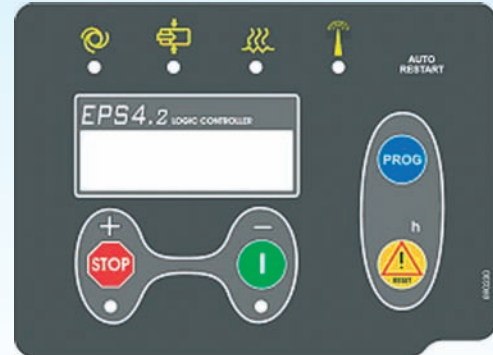

CONTROL PANEL EPS 4.2

An advanced electronic controller. It allows optimum compressor regulation. The system also allows a sequential network of up to six compressors. EPS 4.2 is equipped with an alphanumeric LCD display for showing the functions, the maintenance and the instructions for machine reset, together with the programming of the work parameters. The system can be remote-controlled with a serial interface connecting to a terminal. The EPS4.2 controller display the presence of malfunctioning alarm and the expiration of maintenance intervals.

EPS 3 Control Unit Equipping PS 45/250 VSD Screw compressors



ELECTRONIC CONTROLLER EPS 3

This Control Unit is an advanced electronic controller, it provides to the regulation of the compressed air control unit allowing the highest compressor regulation flexibility. The system also allows a sequential network of up to 6 compressors. It is equipped with an alphanumeric LCD display for showing the functions, the maintenance and the instructions for the machine reset, together with the programming of the working parameters. It is also equipped with a date clock and weekly timer for displaying the time and the date, together with the daily programming of the machine start. The system can be remote-controlled with a serial interface connecting to a terminal.

Rotary Screw Compressors

PS DV SERIES - VARIABLE SPEED

If compared to the conventional compressors, the advantages offered by those equipped with inverter are mainly the following:

1. No electrical adsorption peaks during the motor start.
2. Lowest consumption in electrical power directly comparable to the compressed air output.

Specifications

Model	Max Pressure		F.A.D.		Power		Noise lev. dB(A)	Weight	
	bar max	Psig max	m3/min min/max	CFM min/max	kW	Hp		Kg	lbs
PS 1315-7.5DV	7.5	109	0.4/2.1	14/74	15	20	65	250	551
PS 1315-10DV	10	145	0.4/1.9	14/67	15	20	65	250	551
PS 1315-13DV	13	175	0.3/1.5	11/53	15	20	65	250	551
PS 1515-7.5DV	7.5	109	0.5/2.4	18/85	15	20	69	365	805
PS 1515-10DV	10	145	0.5/2.1	18/74	15	20	69	365	805
PS 1515-13DV	13	175	0.5/1.6	18/57	15	20	69	365	805
PS 1522-7.5DV	7.5	109	0.8/3.50	28/124	22	30	69	395	871
PS 1522-10DV	10	145	0.7/3.05	25/108	22	30	69	395	871
PS 1522-13DV	13	175	0.6/2.6	21/92	22	30	69	395	871
PS 2030-7.5DV	7.5	109	1.0/4.63	35/164	30	40	69	615	1,356
PS 2030-10DV	10	145	1.0/4.15	35/147	30	40	69	615	1,356
PS 2030-13DV	13	175	0.9/3.60	32/127	30	40	69	615	1,356
PS 2037-7.5DV	7.5	109	1.3/5.60	46/198	37	50	69	635	1,400
PS 2037-10DV	10	145	1.2/5.00	42/177	37	50	69	635	1,400
PS 2037-13DV	13	175	1.0/4.50	35/159	37	50	69	635	1,400
PS 45-8DV	7.5	109	1.8/7.4	63/261	45	60	73	1000	2,205
PS 45-10DV	10	145	1.9/6.2	67/219	45	60	73	1000	2,205
PS 45-13DV	13	175	1.4/5.5	49/194	45	60	73	1000	2,205
PS 55-8DV	7.5	109	1.8/9.1	63/321	55	75	73	1100	2,426
PS 55-10DV	10	145	2.1/8.2	74/290	55	75	73	1100	2,426
PS 55-13DV	13	175	1.9/6.2	67/219	55	75	73	1100	2,426
PS 75-8DV	7.5	109	2.4/12.1	85/427	75	100	73	1300	2,867
PS 75-10DV	10	145	2.9/10.6	103/374	75	100	73	1300	2,867
PS 75-13DV	13	175	2.1/8.9	74/314	75	100	73	1300	2,867

The air flow rates have been measured at the following working pressures:

7 bar for mod. 7.5 bar - 9.5 bar for mod. 10 bar - 12.5 bar for mod. 13 bar

The data and performances were recorded in accordance with standard ISO 1217. The sound level was measured in accordance with PNEUROP/CAGI standards.

Notes:

All models are CSA approved.

All models complete with CRN approved for Canada.

All models factory tested prior to shipment.

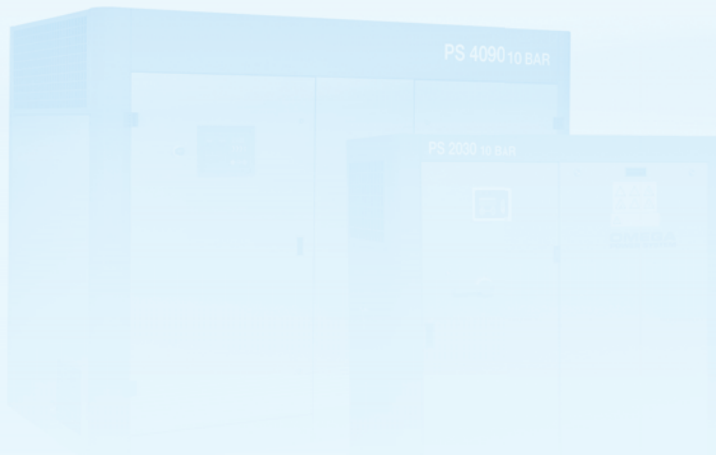

Compressed Air Accessories

Aluminum Air Piping

Ball Valves

Check Valves

Compressed Air Filters

Compressor Oil

Compressor Pumps

Desiccant Air Dryers

Electric Motors

Electronic Auto Drains

Filter Elements

Filter - Regulators - Lubricators

Flex Hose Connectors

Gauges

Magnetic Starters

Oil Monitors

Oil/Water Separators

Pilot Valves

Pneumatic Auto Drains

Pressure Switches

Refrigerated Air Dryers

Remote Air Receivers

Safety Valves

Service Parts

Throttle Controls

Vibration Isolators

Water Separators

5 year limited warranty

OMEGA
POWER SYSTEM

Distributed by:

63 Morrow Rd.
Barrie, ON Canada L4N 3V7
Tel: 800-668-8448 or (705) 721-9500
Fax: (705) 721-8646
Email: info@omegacompressors.com
www.omegacompressors.com